

Kapitel 5

Inhalt

Nussbaum Optipress

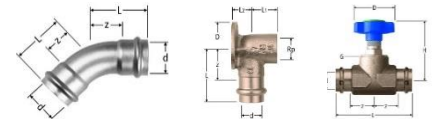

Nussbaum Optiflex-Profiflex



Nussbaum Optiflex Flowpress

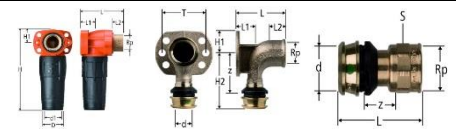

Nussbaum Optiflex Verteiler & Einlegematerial



IRG Sanipex

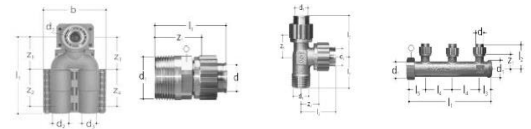

Jansen Verbundrohre & Verbindungstechnik



PEX - Verschraubungsprogramm



Inox Rohre & Pressfittinge



Messing, Rotguss, Chromefittinge



Klemmring-Verschraubung, UNI Grip / Rep



Kapitel 5

Inhalt	Seite
Optipress Rohre, Bögen, Winkel, T-Stücke, Übergänge	1 - 8
Optipress Verschraubungen	8 - 10
Optipress Schräg-, Geradsitzventile, Rückflussverhinderer	10 - 12
Optiflex Profix Rohre, Dosen, Fittinge	13 - 18
Optiflex Flowpress Dosen, Fittinge	19 - 26
Optiflex Verteiler & Zubehör	27 - 28
Optiflex Einlege & Befestigungsmaterial	29 - 31
Bau & Abpresszapfen	32
IRG Sanipex Rohre, Dosen, Fittinge	33 - 36
IRG Sanipex Verteiler & Zubehör	37 - 38
Jansen Verbundrohre	39 - 40
Jansen Fittinge	40 - 44
PEX - Rohre, Fittinge	45 - 47
PEX - Verteiler, Anschlussverschraubung	48
Inox Rohre und Pressfittinge	49 - 52
Messing / Rotguss Fittinge	53 - 60
Chrome Fittinge	61 - 62
Klemmring - Verschraubungen	63
UNI Grip / Rep	64



Nussbaum Optipress

Rohre

Fittings

Armaturen



Optipress Edelstahlrohr

1.4521

15	47.818222	5.00
18	47.818223	6.20
22	47.818224	8.60
28	47.818225	10.90
35	47.818226	16.30
42	47.818227	20.90
54	47.818228	26.50

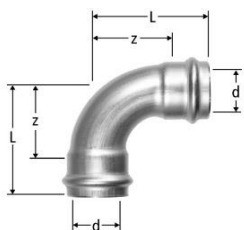

Optipress-Aquaplust-Bogen 90°

15	47.810022	7.90
18	47.810023	9.20
22	47.810024	10.90
28	47.810025	13.80
35	47.810026	18.40
42	47.810027	29.00
54	47.810028	38.60

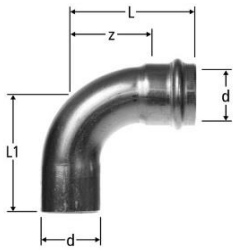

Optipress-Aquaplust-Bogen 90°

mit Einsteckende

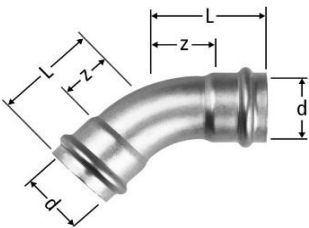
15	47.810122	8.00
18	47.810123	9.20
22	47.810124	10.90
28	47.810125	13.90
35	47.810126	18.40
42	47.810127	29.00
54	47.810128	38.60

Optipress-Aquaplust-Bogen 45°

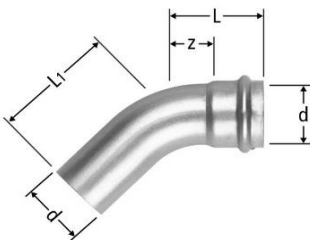
15	47.810322	7.90
18	47.810323	9.20
22	47.810324	10.90
28	47.810325	13.80
35	47.810326	18.20
42	47.810327	29.00
54	47.810328	38.30

Optipress-Aquaplust-Bogen 45°

mit Einsteckende

15	47.810422	8.00
18	47.810423	9.20
22	47.810424	10.90
28	47.810425	13.90
35	47.810426	18.20
42	47.810427	29.00
54	47.810428	38.30

Optipress-Aquaplust-Bogen 90°

mit Aussengewinde

15 x 1/2"	47.810522	13.60
18 x 1/2"	47.810523	13.60
18 x 3/4"	47.810529	16.80
22 x 3/4"	47.810524	17.50
28 x 1"	47.810525	24.60
35 x 1.1/4"	47.810526	35.10
42 x 1.1/2"	47.810527	61.50
54 x 2"	47.810528	80.00

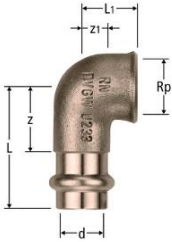
Optipress-Aquaplust-Winkel

mit Innengewinde

15 x 3/8"	47.810621	18.80
15 x 1/2"	47.810622	12.10
18 x 1/2"	47.810623	13.30
18 x 3/4"	47.810626	18.90
22 x 1/2"	47.810624	19.30
22 x 3/4"	47.810627	17.20
28 x 1/2"	47.810625	26.10
28 x 3/4"	47.810629	26.20
28 x 1"	47.810628	21.90
35 x 1.1/4"	47.810630	35.10
42 x 1.1/2"	47.810631	56.50
54 x 2"	47.810632	114.00



Optipress-Aquaplust-Winkel

mit Einsteckende und Innengewinde

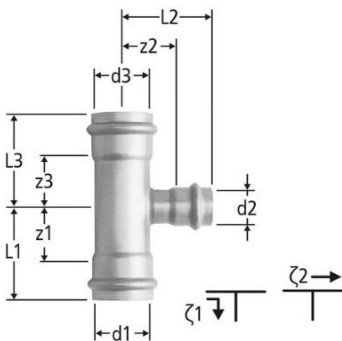
15 x 1/2"	47.810720	17.90
-----------	-----------	-------

Optipress-Aquaplust-T-Stück

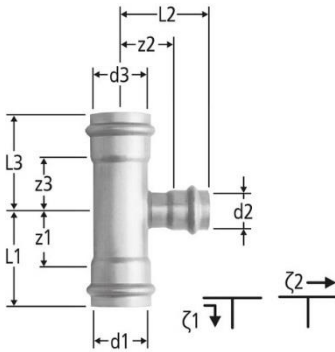
15	47.811022	13.10
18	47.811023	13.40
22	47.811024	14.00
28	47.811025	16.80
35	47.811026	21.30
42	47.811027	30.50
54	47.811028	35.40

Optipress-Aquaplus-T-Stück

18 x 15 x 15	47.811029	15.10
18 x 15 x 18	47.811030	14.50
22 x 15 x 15	47.811031	21.50
22 x 15 x 22	47.811032	14.10
22 x 18 x 18	47.811053	18.50
22 x 18 x 22	47.811033	14.20
22 x 22 x 15	47.811054	24.00
28 x 22 x 22	47.811034	26.00
28 x 15 x 28	47.811035	16.70
28 x 18 x 28	47.811055	17.00
28 x 22 x 28	47.811036	17.00
35 x 15 x 35	47.811037	21.20
35 x 18 x 35	47.811061	21.20
35 x 22 x 35	47.811038	21.20
35 x 28 x 28	47.811039	29.10
35 x 28 x 35	47.811040	21.20
42 x 22 x 42	47.811041	30.70
42 x 28 x 42	47.811042	30.70
42 x 35 x 42	47.811044	30.70
54 x 22 x 54	47.811045	35.60
54 x 28 x 54	47.811046	35.60
54 x 35 x 54	47.811047	35.60
54 x 42 x 54	47.811049	35.60

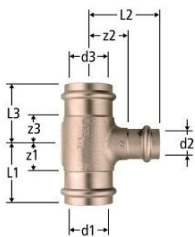
Optipress-Aquaplus-T-Stück

15 x 22 x 15	47.811050	17.30
42 x 15 x 42	47.811063	36.60
42 x 35 x 35	47.811043	43.70

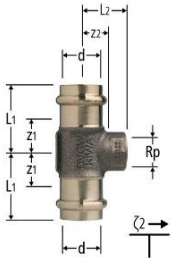
Optipress-Aquaplust-Stück

mit Innengewinde

15 x 1/2" x 15	47.811322	11.90
18 x 1/2" x 18	47.811323	13.20
22 x 1/2" x 22	47.811324	13.20
22 x 3/4" x 22	47.811329	13.20
28 x 1/2" x 28	47.811325	14.50
28 x 3/4" x 28	47.811330	16.20
35 x 1/2" x 35	47.811326	18.70
42 x 1/2" x 42	47.811327	22.80
54 x 1/2" x 54	47.811328	28.10



Optipress-Aquaplust-T-Stück

mit Aussengewinde

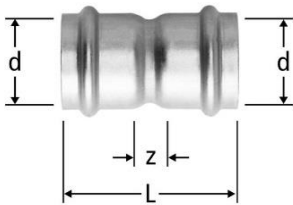
22 x 3/4" x 22	47.811524	15.60
28 x 3/4" x 28	47.811525	19.80
35 x 3/4" x 35	47.811526	21.50
42 x 3/4" x 42	47.811527	28.80

Optipress-Aquaplust-Muffe

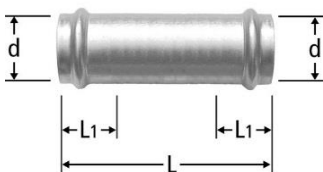
15	47.812022	5.60
18	47.812023	6.00
22	47.812024	7.00
28	47.812025	7.90
35	47.812026	9.90
42	47.812027	13.40
54	47.812028	16.10

Optipress-Aquaplust-Schiebemuffe

15	47.812222	9.20
18	47.812223	9.60
22	47.812224	10.90
28	47.812225	12.70
35	47.812226	14.10
42	47.812227	16.30
54	47.812228	22.30

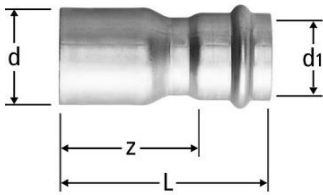
Optipress-Aquaplus-Reduktion

mit Einsteckende

18 x 15	47.812122	5.90
22 x 15	47.812123	6.40
22 x 18	47.812124	6.70
28 x 15	47.812125	7.40
28 x 22	47.812126	7.40
28 x 18	47.812127	7.40
35 x 22	47.812128	11.60
35 x 28	47.812129	11.60
42 x 22	47.812131	16.10
42 x 28	47.812133	16.10
42 x 35	47.812134	14.90
54 x 28	47.812138	21.00
54 x 35	47.812139	21.50
54 x 42	47.812140	21.10

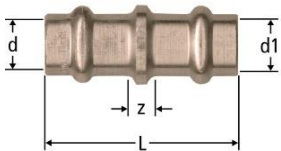
Optipress-Aquaplus-Übergang

auf alte Kupferrohre

15 x 14	47.812423	13.60
18 x 17	47.812424	21.70

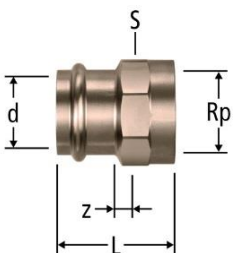
Optipress-Aquaplus-Übergang

mit Innengewinde

15 x 3/8"	47.813321	9.00
15 x 1/2"	47.813322	9.00
15 x 3/4"	47.813336	9.00
18 x 1/2"	47.813323	9.80
18 x 3/4"	47.813324	9.80
22 x 1/2"	47.813337	10.30
22 x 3/4"	47.813325	10.30
22 x 1"	47.813326	10.30
28 x 1/2"	47.813328	17.40
28 x 3/4"	47.813327	13.80
28 x 1"	47.813329	13.80
28 x 1.1/4"	47.813330	20.50
35 x 3/4"	47.813339	26.10
35 x 1"	47.813338	22.80
35 x 1.1/4"	47.813331	18.30
42 x 1.1/4"	47.813332	32.60
42 x 1.1/2"	47.813333	26.50
54 x 1.1/2"	47.813334	53.00
54 x 2"	47.813335	38.90

Optipress-Aquaplust-Übergang

mit Aussengewinde

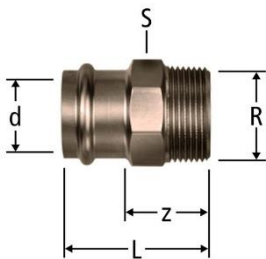

15 x 3/8"	47.813520	9.00
15 x 1/2"	47.813521	9.00
15 x 3/4"	47.813522	9.00
18 x 1/2"	47.813523	9.80
18 x 3/4"	47.813524	9.80
22 x 1/2"	47.813536	10.50
22 x 3/4"	47.813525	10.50
22 x 1"	47.813527	10.50
28 x 3/4"	47.813528	13.80
28 x 1"	47.813529	13.80
28 x 1.1/4"	47.813530	20.70
35 x 1"	47.813537	18.20
35 x 1.1/4"	47.813531	18.20
35 x 1.1/2"	47.813538	25.40
42 x 1.1/4"	47.813532	32.60
42 x 1.1/2"	47.813533	26.50
54 x 1.1/2"	47.813539	55.00
54 x 2"	47.813534	39.70

Optipress-Aquaplust-Übergang

mit Einsteckende und Innengewinde

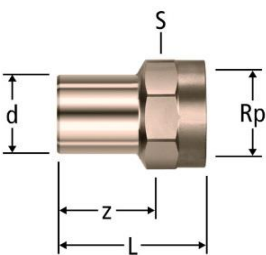

15 x 1/2"	47.813421	11.00
18 x 1/2"	47.813422	11.40
18 x 3/4"	47.813423	12.10
22 x 1/2"	47.813424	12.10
22 x 3/4"	47.813425	14.10
28 x 3/4"	47.813428	15.00
28 x 1"	47.813429	20.60
35 x 1"	47.813430	34.10
35 x 1.1/4"	47.813431	23.30
42 x 1.1/2"	47.813433	34.30
54 x 2"	47.813335	49.80

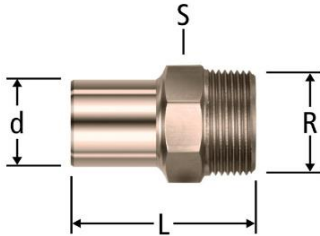
Optipress-Aquaplus-Übergang

mit Einsteckende und Aussengewinde

15 x 1/2"	47.813621	9.00
18 x 1/2"	47.813622	9.80
18 x 3/4"	47.813623	12.10
22 x 1/2"	47.813624	12.80
22 x 3/4"	47.813625	10.30
28 x 1"	47.813629	13.80
35 x 1.1/4"	47.813631	18.40
42 x 1.1/2"	47.813633	26.50

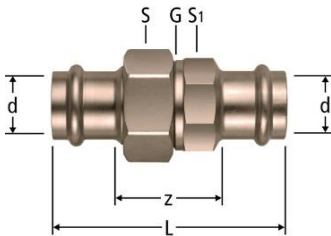
Optipress-Aquaplus-Verschraubung

15	47.814122	28.30
18	47.814123	32.40
22	47.814124	39.30
28	47.814125	52.50
35	47.814126	56.00
42	47.814127	69.50
54	47.814128	105.50

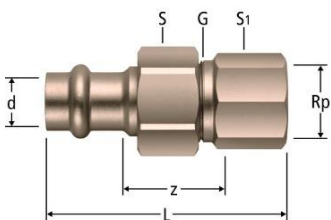
Optipress-Aquaplus-Verschraubung

mit Innengewinde

15 x 1/2"	47.814421	15.80
18 x 1/2"	47.814423	18.70
22 x 3/4"	47.814425	21.50
22 x 1"	47.814426	22.00
28 x 1"	47.814429	26.20
35 x 1.1/4"	47.814431	43.20
42 x 1.1/2"	47.814433	49.40
54 x 2"	47.814434	88.00

Optipress
Artikel-Nr.
Fr. / Stk.
Optipress-Aquaplus-Verschraubung

(Rabatt-Gr.47.02)

mit Aussengewinde

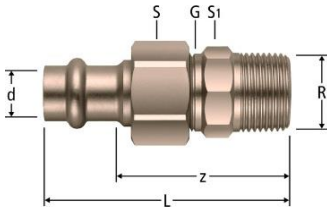

15 x 1/2"	47.814620	15.80
18 x 1/2"	47.814622	18.70
22 x 1/2"	47.814624	25.90
22 x 3/4"	47.814625	25.90
22 x 1"	47.814627	25.90
28 x 1"	47.814629	34.60
35 x 1.1/4"	47.814631	43.20
42 x 1.1/2"	47.814633	49.40
54 x 2"	47.814634	88.00

Optipress-Aquaplus-Winkelverschraubung

(Rabatt-Gr.47.02)

mit Innengewinde

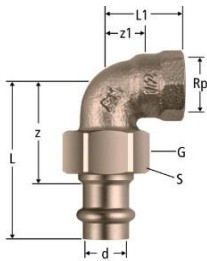

15 x 1/2"	47.814722	25.90
18 x 1/2"	47.814723	28.80
22 x 3/4"	47.814725	40.10
22 x 1"	47.814726	44.90
28 x 1"	47.814729	52.00
35 x 1.1/4"	47.814731	68.50
42 x 1.1/2"	47.814733	99.50
54 x 2"	47.814734	172.50

Optipress-Aquaplus-Verschraubung

(Rabatt-Gr.45.01)

mit Pressmuffe

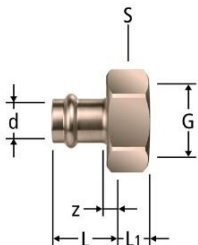

18 x 1.1/4"	45.922023	27.60
18 x 1.1/2"	45.922024	35.90
22 x 1.1/4"	45.922025	15.60
22 x 1.1/2"	45.922026	15.60
28 x 1"	45.922028	15.60
28 x 1.1/2"	45.922029	26.20
28 x 2"	45.922030	46.80
35 x 2"	45.922033	41.70
42 x 2.1/4"	45.922036	76.50
42 x 2.3/8"	45.922037	103.00
54 x 2.3/4"	45.922038	82.00

Optipress
Artikel-Nr.
Fr. / Stk.
Optipress-Aquaplus-Verschraubung

(Rabatt-Gr.45.01)

mit Pressmuffe

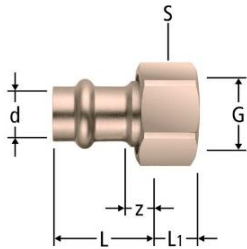

15 x 3/4"	45.922122	7.20
18 x 3/4"	45.922123	7.80
22 x 3/4"	45.922135	22.00
22 x 1"	45.922124	8.40
28 x 1.1/4"	45.922125	10.70
35 x 1.1/2"	45.922126	15.00
42 x 1.3/4"	45.922127	25.70

Optipress-Aquaplus-Anschlusswinkel

(Rabatt-Gr.47.02)

mit Wandflansch

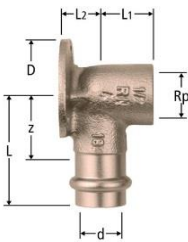

15 x 1/2"	47.815021	17.20
18 x 1/2"	47.815022	18.40
22 x 1/2"	47.815024	21.90

Optipress-Aquaplus-Anschlusswinkel

(Rabatt-Gr.47.02)

mit abgesetztem Wandflansch

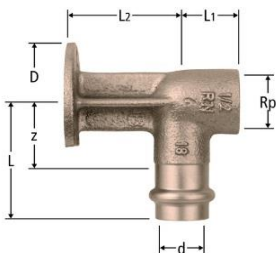

15 x 1/2"	47.815421	22.70
18 x 1/2"	47.815422	26.50
22 x 1/2"	47.815424	32.90

Optipress-Aquaplus-Schrägsitzventil

(Rabatt-Gr.47.02)

mit Easy-Top-Oberteil

aus Messing

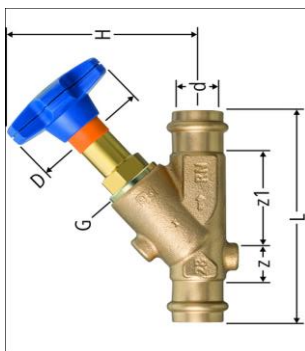

15	47.820022	54.50
18	47.820023	59.00
22	47.820024	66.00
28	47.820025	84.00
35	47.820026	123.00
42	47.820027	181.00
54	47.820028	230.00

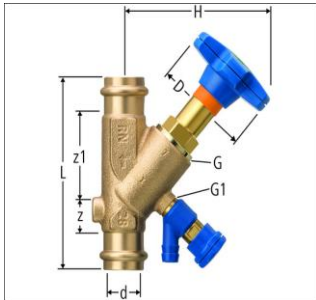

Optipress-Aquaplus-Schrägsitzventil mit Entleerventil

 mit Easy-Top-Oberteil
 aus Messing

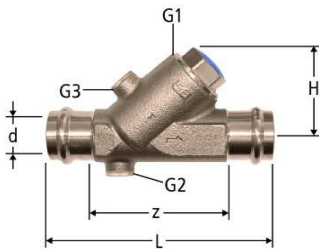
15	47.820222	72.50
18	47.820223	77.50
22	47.820224	83.50
28	47.820225	101.00
35	47.820226	140.50
42	47.820227	198.50
54	47.820228	249.00

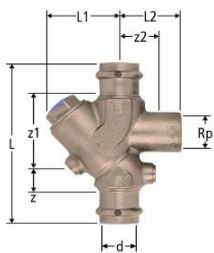

Optipress-Aquaplus-Rückflussverhinderer EA

15	47.816322	69.00
22	47.816324	99.50
28	47.816325	100.00

Optipress-Aquaplus-Rückflussverhinderer EA

 für den direkten Anschluss von
 Sicherheitsventil

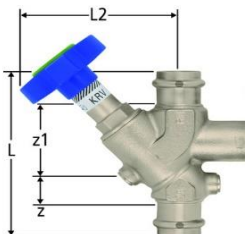
22	47.816424	117.00
28	47.816425	117.50
35	47.816426	155.50

Optipress-Aquaplus-Absperr-Sicherheitsgarnitur SW

 zu Stand-Wassererwärmer,
 Sicherheitsventil 6 bar fest eingestellt,
 aus kombiniertem Rückflussverhinderer /
 Absperrventil KRV,
ohne Sicherheitsventil

22	47.816834	143.00
28	47.816835	173.00

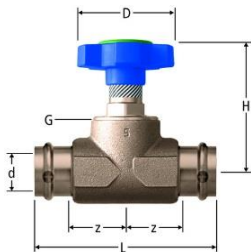
Optipress-Aquaplus-Geradsitzventil

 mit Easy-Top-Oberteil,
aus Messing

15	47.820422	50.00
18	47.820423	51.50
22	47.820424	64.00
28	47.820425	83.00
35	47.820426	106.50
42	47.820427	145.50
54	47.820428	216.00

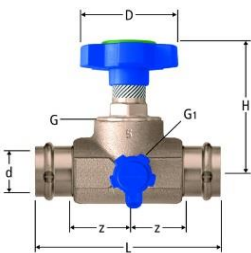
**Optipress-Aquaplus-Geradsitzventil
mit Entleerventil**

 mit Easy-Top-Oberteil,
aus Messing

22	47.820624	86.50
----	-----------	-------



Optiflex-Profix



Optiflex-Rohr

(Rabatt-Gr. 46.01)

Optiflex-Rohr flexibel,
in Schutzrohr in Ringen
PE-Xc-Rohr

16

46.874021

4.40

20

46.874022

6.20



Optiflex-Rohr

(Rabatt-Gr. 46.01)

Optiflex-Rohr flexibel,
in Schutzrohr in Ringen
PB-Rohr

25

46.874023

10.40

Optiflex - Profix (Rabatt-Gr. 48.04)
Dim.
Artikel-Nr.
Fr. / Stk.

Optiflex-Profix-Dose

 2-teilig, mit flexiblem Dosenfuss
 Anschlusswinkel schallentkoppelt

1/2" x 16
48.510021
24.80
1/2" x 20
48.510022
36.90

Optiflex-Profix-Dose, lang

 2-teilig, mit flexiblem Dosenfuss
 Anschlusswinkel schallentkoppelt

1/2" x 16
48.510521
26.90
1/2" x 20
48.510522
39.00

Optiflex-Profix-Doppeldose

 3-teilig, mit flexiblem Dosenfuss
 Anschlusswinkel schallentkoppelt

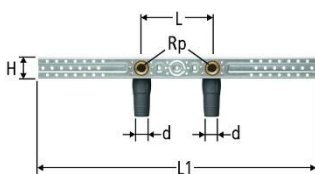
1/2" x 16 x 16
48.511021
47.50
1/2" x 20 x 16
48.511022
53.50
1/2" x 20 x 20
48.511023
66.50

Optiflex-Profix-Anschluss-Set

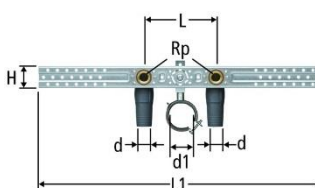
für Bad und Dusche

16
48.511221
66.50

Optiflex-Profix-Anschluss-Set

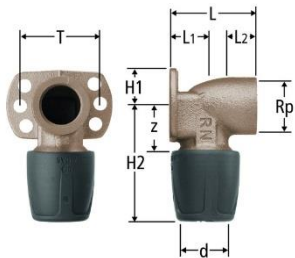
für Waschtisch

153
48.511321
78.00

Optiflex - Profix (Rabatt-Gr. 48.04)
Dim.
Artikel-Nr.
Fr. / Stk.

Optiflex-Profix-Anschlusswinkel

mit Wandflansch

L=43

1/2" x 16

48.511521

15.80

L=43

1/2" x 20

48.511522

20.10

L=45

3/4" x 20

48.511523

25.30

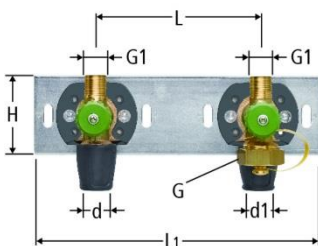

Optiflex-Profix-Küchengarнитель

mit Schalldämmung

16 x 16

48.512521

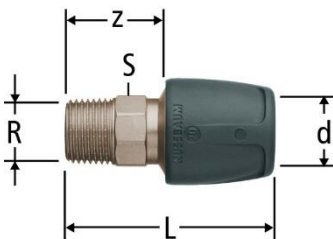
120.00

Optiflex-Profix-Übergang

mit Aussengewinde

1/2" x 16

48.513021

11.00

1/2" x 20

48.513022

14.80

3/4" x 16

48.513024

14.80

3/4" x 20

48.513023

20.10

3/4" x 25

48.513026

23.20

1" x 25

48.513027

25.30

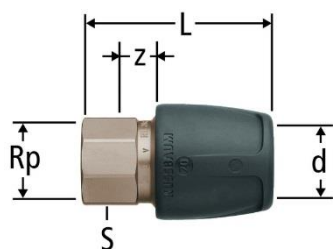
Optiflex-Profix-Übergang

mit Innengewinde

1/2" x 16

48.513121

11.00

1/2" x 20

48.513122

14.80

3/4" x 16

48.513124

14.80

3/4" x 20

48.513123

20.10

3/4" x 25

48.513126

23.20

1" x 25

48.513127

25.30

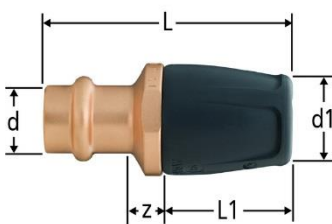
Optiflex - Profix (Rabatt-Gr. 48.04)
Dim.
Artikel-Nr.
Fr. / Stk.

Optiflex-Profix-Übergang

 auf Optipress-Aquaplus,
mit Pressmuffe

15 x 16
48.513321
18.40
18 x 16
48.513322
20.60
22 x 20
48.513323
26.50

Optiflex-Profix-Übergang

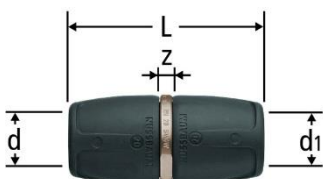
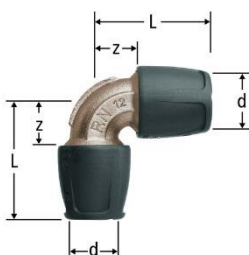
 auf Optipress-Aquaplus,
mit Einsteckende

15 x 16
48.513421
17.40
18 x 16
48.513422
19.60
22 x 20
48.513423
24.80
22 x 25
48.513425
36.90

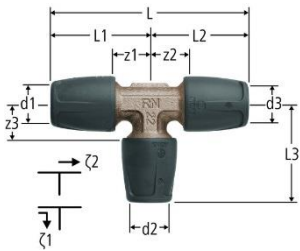
Optiflex-Profix-Kupplung
16 x 16
48.513621
13.70
20 x 20
48.513622
21.10
20 x 16
48.513623
21.10
25 x 25
48.513626
26.40
25 x 20
48.513627
26.90

Optiflex-Profix-Bogen
16
48.514021
15.80
20
48.514022
24.20
25
48.514023
38.00

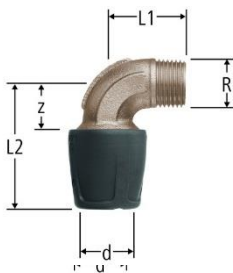

Optiflex-Profix-T-Stück

16	48.514221	19.00
16 x 20 x 16	48.514222	26.40
20 x 16 x 16	48.514223	26.40
20 x 16 x 20	48.514224	26.40
20 x 20 x 16	48.514225	26.40
20	48.514226	28.50
25 x 20 x 25	48.514230	42.50
25	48.514231	42.50

Optiflex-Profix-Bogen

mit Aussengewinde

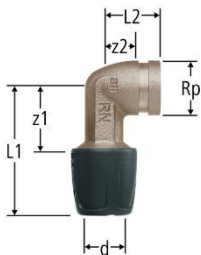
1/2" x 16	48.514521	15.80
1/2" x 20	48.514522	19.00
3/4" x 20	48.514523	23.20
3/4" x 25	48.514524	40.00

Optiflex-Profix-Winkel

mit Innengewinde

1/2" x 16	48.514621	15.80
1/2" x 20	48.514622	22.50

Optiflex-Profix-Übergang

auf MeplaFix, mit Stecknippel

16	48.518021	13.70
----	-----------	-------

Optiflex - Profix (Rabatt-Gr. 48.04)

Dim.

Artikel-Nr.

Fr. / Stk.



Optiflex-Profix-Bogen

auf MeplaFix, mit Stecknippel

16

48.518121

15.80



Optiflex-Profix-Verbindungsset

bestehend aus Schraubkappe,
Klemmring, Krallring

16

48.519021

5.30

20

48.519022

6.30



Optiflex Flowpress



Optiflex-Flowpress-Dose

2-teilig, mit flexiblem Dosenfuss
Anschlusswinkel schallentkoppelt

1/2" x 16	48.420021	24.80
1/2" x 20	48.420022	36.90



Optiflex-Flowpress-Dose, lang

2-teilig, mit flexiblem Dosenfuss
Anschlusswinkel schallentkoppelt

1/2" x 16	48.420521	26.90
1/2" x 20	48.420522	39.00



Optiflex-Flowpress-Doppeldose

3-teilig, mit flexiblem Dosenfuss
Anschlusswinkel schallentkoppelt

1/2" x 16 x 16	48.421021	47.50
1/2" x 20 x 16	48.421022	53.50
1/2" x 20 x 20	48.421023	66.50

Optiflex - Flowpress (Rabatt-Gr. 48.04) Dim. Artikel-Nr. Fr. / Stk.



Optiflex-Flowpress-Doppeldose, lang

3-teilig, mit flexiblem Dosenfuss	1/2" x 16 x 16	48.421121	50.00
Anschlusswinkel schallentkoppelt	1/2" x 20 x 16	48.421122	56.00
	1/2" x 20 x 20	48.421123	68.50

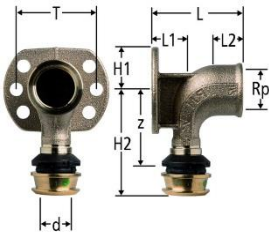

Optiflex-Flowpress-Anschlusswinkel

mit Wandflansch	L=45mm	1/2" x 16	48.421521	14.80
		1/2" x 20	48.421522	19.00

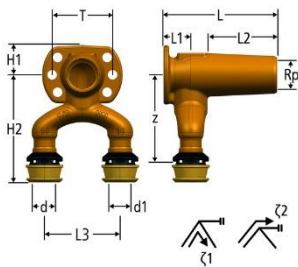

Optiflex-Flowpress-Doppel-Anschlusswinkel

mit Wandflansch	L=75mm	1/2" x 16 x 16	48.421921	45.00
	L=75mm	1/2" x 20 x 16	48.421922	50.00
	L=90mm	1/2" x 16 x 16	48.421923	51.00

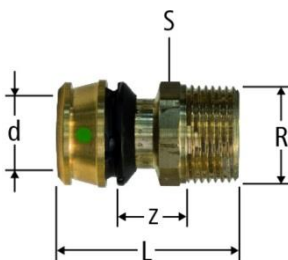

Optiflex-Flowpress-Übergang

mit Aussengewinde	1/2" x 16	48.423021	9.40
	1/2" x 20	48.423022	12.90
	3/4" x 16	48.423023	12.90
	3/4" x 20	48.423024	16.00
	3/4" x 25	48.423025	16.00
	1" x 25	48.423026	17.90
	1" x 32	48.423027	22.20
	1.1/4" x 40	48.423028	24.20

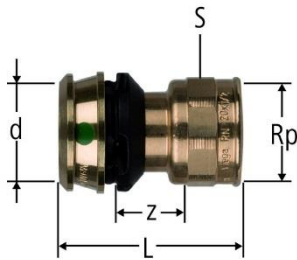
Optiflex - Flowpress (Rabatt-Gr. 48.04)
Dim.
Artikel-Nr.
Fr. / Stk.

Optiflex-Flowpress-Übergang

mit Innengewinde

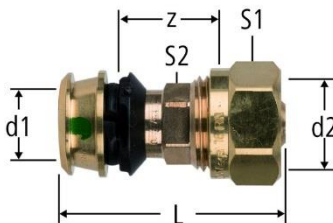
1/2" x 16	48.423121	9.40
1/2" x 20	48.423122	12.90
3/4" x 16	48.423123	12.90
3/4" x 20	48.423124	15.00
3/4" x 25	48.423125	16.00
1" x 25	48.423126	16.00
1" x 32	48.423127	17.90
1.1/4" x 32	48.423128	22.20
1.1/4" x 40	48.423129	24.20

Optiflex-Flowpress-Übergang

für formstabile Optiflex-Rohre alt/neu

16	48.423521	11.00
20	48.423522	14.00

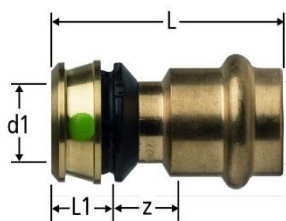
Optiflex-Flowpress-Übergang

 auf Optipress-Aquaplast,
mit Pressmuffe

16 x 15	48.423321	10.40
16 x 18	48.423322	10.90
20 x 15	48.423323	11.60
20 x 18	48.423324	12.60
20 x 22	48.423325	14.50
25 x 22	48.423326	17.30
32 x 28	48.423327	24.00
40 x 28	48.423328	34.80
40 x 35	48.423329	41.10

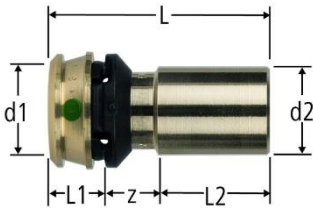
Optiflex - Flowpress (Rabatt-Gr. 48.04)
Dim.
Artikel-Nr.
Fr. / Stk.

Optiflex-Flowpress-Übergang

 auf Optipress-Aquaplus,
mit Einsteckende

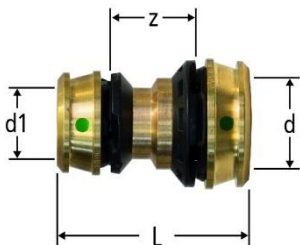
16 x 15	48.423421	9.60
16 x 18	48.423422	13.20
20 x 18	48.423423	11.80
20 x 22	48.423424	17.90
25 x 22	48.423425	16.60
32 x 28	48.423426	18.20
40 x 35	48.423427	23.20

Optiflex-Flowpress-Kupplung

16	48.423621	12.70
20	48.423622	15.30
20 x 16	48.423623	15.30
25	48.423624	16.30
25 x 16	48.423625	16.80
25 x 20	48.423626	17.90
32	48.423627	17.40
32 x 20	48.423628	21.60
32 x 25	48.423629	23.20
40	48.423630	25.30
40 x 32	48.423631	25.30

Optiflex-Flowpress-Bogen 45°

25	48.424121	16.80
32	48.424122	19.00
40	48.424123	30.00

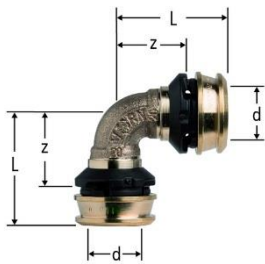
Optiflex - Flowpress (Rabatt-Gr. 48.04)
Dim.
Artikel-Nr.
Fr. / Stk.

Optiflex-Flowpress-Bogen 90°

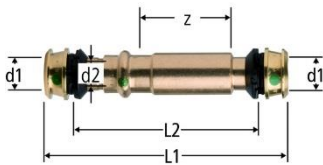
16	48.424021	12.70
20	48.424022	13.70
25	48.424023	15.80
32	48.424024	17.90
40	48.424025	28.00

Optiflex-Flowpress-Schiebemuffe

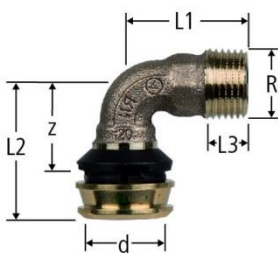
16	48.423721	44.30
20	48.423722	47.40
25	48.423723	55.50
32	48.423724	66.50
40	48.423725	79.00

Optiflex-Flowpress-Bogen 90°

mit Aussengewinde

16 x 1/2"	48.424521	13.90
16 x 3/4"	48.424522	16.60
20 x 1/2"	48.424523	16.50
20 x 3/4"	48.424524	17.80
25 x 3/4"	48.424525	21.40
25 x 1"	48.424526	27.40
32 x 1"	48.424527	30.00
40 x 1.1/4"	48.424528	37.50

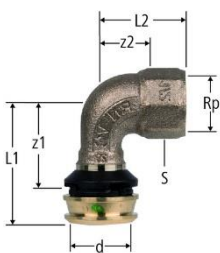

Optiflex-Flowpress-Winkel

mit Innengewinde

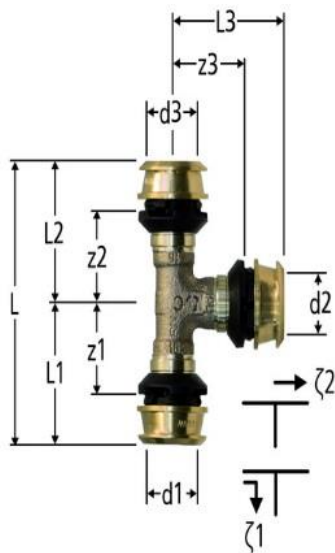
16 x 1/2"	48.424621	14.80
20 x 1/2"	48.424622	23.20
20 x 3/4"	48.424623	24.20
25 x 3/4"	48.424624	26.40
32 x 1"	48.424625	33.50

Optiflex-Flowpress-T-Stück

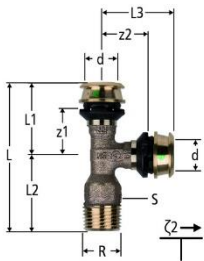
16 x 16 x 16	48.424221	15.10
16 x 20 x 16	48.424222	17.30
20 x 16 x 16	48.424223	17.30
20 x 16 x 20	48.424224	17.30
20 x 20 x 16	48.424225	17.30
20 x 20 x 20	48.424226	17.30
25 x 16 x 16	48.424227	23.80
25 x 16 x 20	48.424228	21.40
25 x 16 x 25	48.424229	21.40
25 x 20 x 20	48.424230	21.40
25 x 20 x 25	48.424231	21.40
25 x 25 x 16	48.424232	27.10
25 x 25 x 25	48.424233	19.70
32 x 16 x 25	48.424234	36.90
32 x 16 x 32	48.424235	28.10
32 x 20 x 20	48.424236	39.00
32 x 20 x 32	48.424237	28.50
32 x 25 x 25	48.424238	28.50
32 x 25 x 32	48.424239	29.50
32 x 32 x 32	48.424240	28.30
40 x 20 x 40	48.424241	39.00
40 x 25 x 32	48.424242	49.00
40 x 25 x 40	48.424243	38.00
40 x 32 x 32	48.424244	37.00
40 x 32 x 40	48.424245	38.00
40 x 40 x 40	48.424246	44.00

Optiflex-Flowpress-T-Stück

mit Aussengewinde

1/2" x 16 x 16	48.424421	23.30
3/4" x 16 x 16	48.424422	30.70
3/4" x 20 x 20	48.424423	36.70

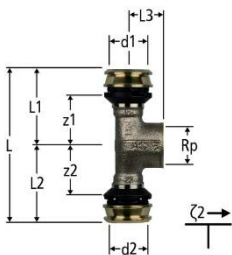
Optiflex-Flowpress-T-Stück

mit Innengewinde

16 x 1/2" x 16	48.424321	21.10
20 x 1/2" x 20	48.424322	21.80
25 x 1/2" x 25	48.424323	26.00
25 x 3/4" x 25	48.424324	22.90
32 x 3/4" x 32	48.424325	31.20
40 x 3/4" x 40	48.424326	40.50

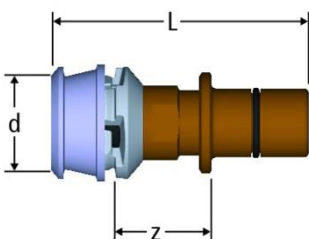
Optiflex-Flowpress-Übergang

auf MeplaFix, mit Stecknippel

16	48.428021	13.70
20	48.428022	19.00

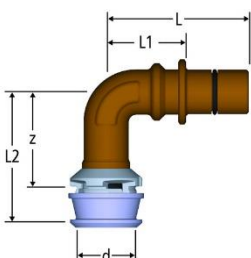

Optiflex-Flowpress-Bogen

auf MeplaFix, mit Stecknippel

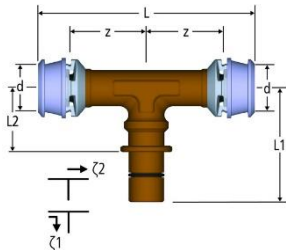
16	48.428121	15.80
----	-----------	-------

Optiflex-Flowpress-T-Stück

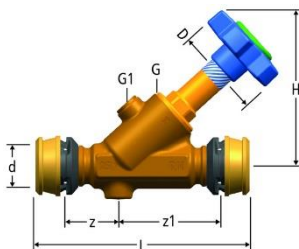
auf MeplaFix, mit Stecknippel

16
48.428221
26.40

Optiflex-Flowpress-Schrägsitzventil

mit Easy-Top-Oberteil aus Rotguss

16
48.651022
67.50
20
48.651023
72.00
25
48.651024
79.00
32
48.651025
101.50
40
48.651026
116.00

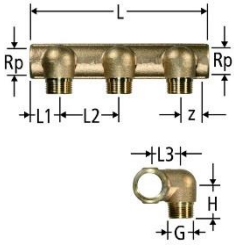
Optiflex - Verteiler & Zubehör	Dim.	Artikel-Nr.	Fr. / Stk.
--------------------------------	------	-------------	------------



Optiflex-Verteiler

(Rabatt-Gr. 46.02)

mit Innengewinde

3/4" x 1	46.860221	27.00
3/4" x 2	46.860222	30.00
3/4" x 3	46.860223	39.00
3/4" x 4	46.860224	47.00
3/4" x 5	46.860225	56.00



Optiflex-Erweiterungs-Verteilerstück

(Rabatt-Gr. 46.02)

mit loser Mutter

3/4"	46.861205	43.30
------	-----------	-------

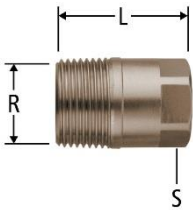

Optiflex-Verschlusszapfen

(Rabatt-Gr. 46.02)

zu Verteiler

3/4"	46.860805	11.00
1"	46.860806	19.00

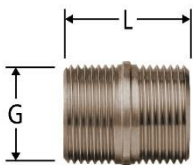

Optiflex-Doppelnippel

(Rabatt-Gr. 46.02)

zu Verteiler

3/4"	46.860905	7.90
1"	46.860906	12.20

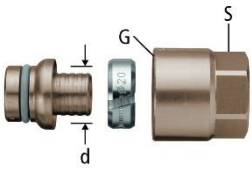
Optiflex - Verteiler & Zubehör
Dim.
Artikel-Nr.
Fr. / Stk.

Optiflex-Klemmverschraubung

(Rabatt-Gr. 46.02)

3/4" x 16
46.860521
6.30
3/4" x 20
46.860522
7.40

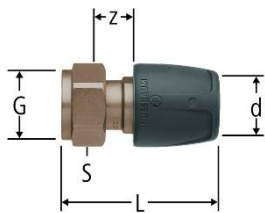
zu Verteiler

Optiflex-Profix-Verteileranschluss

(Rabatt-Gr. 48.04)

3/4" x 16
48.515021
7.40
3/4" x 20
48.515022
8.40

zu Verteiler

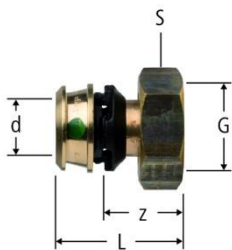
Optiflex-Flowpress-Verteileranschluss

(Rabatt-Gr. 48.04)

16 x 3/4"
48.425021
8.40
20 x 3/4"
48.425022
9.50
25 x 3/4"
48.425023
18.00

zu Verteiler

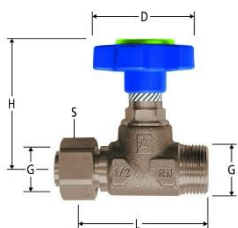

Optiflex-Geradsitzventil

(Rabatt-Gr. 46.02)

3/4"
46.861605
60.50

zu Verteiler

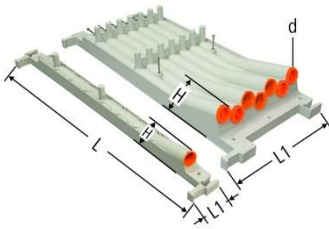
Einlege & Befestigungsmaterial	Dim.	Artikel-Nr.	Fr. / Stk.
--------------------------------	------	-------------	------------



Optiflex-Einlegekasten

(Rabatt-Gr. 48.04)

für Optiflex-Rohre 16 und 20

16 / 20 x 1

48.705421

10.00

16 / 20 x 7

48.705423

35.90

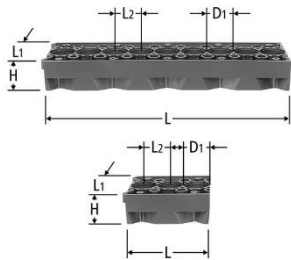

Optiflex-Einlegebalken

(Rabatt-Gr. 46.02)

9

46.875021

12.50

3

46.875022

4.60



Optiflex-Einlegebüchse

(Rabatt-Gr. 46.02)

für Rohre 16 zu Einlegebalken

46.875321

0.25

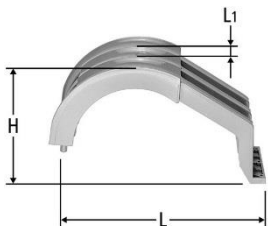

Optiflex-Rohrbrücke

(Rabatt-Gr. 46.02)

für 3 Rohre zu Optiflex-Einlegebalken

3

46.875621

6.00

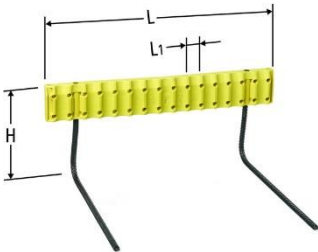
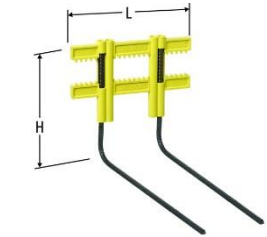
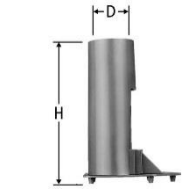
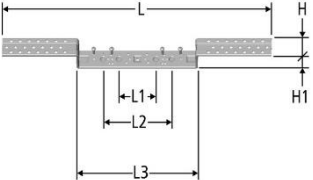
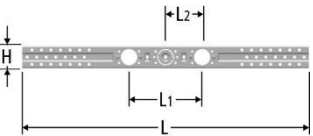
	Einlege & Befestigungsmaterial	Dim.	Artikel-Nr.	Fr. / Stk.
	Optiflex-Mehrfach-Rohrstütze (Rabatt-Gr. 46.02)	16 / 20 - 15	46.875821	16.80
	Optiflex-Rohrstütze (Rabatt-Gr. 46.02)		46.876921	6.30
	Rohrstütze FAWA (Rabatt-Gr. 46.02)		46.877021	7.90
	Optiflex-Montageschiene (Rabatt-Gr. 48.04) für Mauerwerk zu Optiflex-Dosen	80 / 153	48.505521	12.70
	Optiflex-Montageschiene (Rabatt-Gr. 48.04) zu Optiflex-Dosen	153	48.505621	12.70

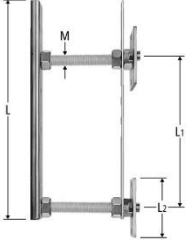
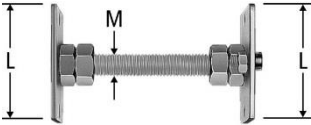
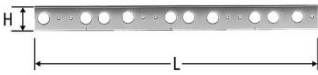
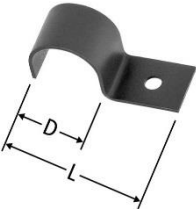
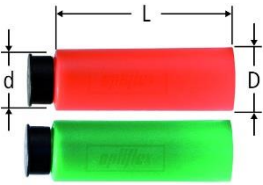
Einlege & Befestigungsmaterial	Dim.	Artikel-Nr.	Fr. / Stk.		
	Optiflex-Doppel-Halterung (Rabatt-Gr. 46.02)	46.857221	36.10		
zu Optiflex-Dosen					
	Optiflex-Einzel-Halterung (Rabatt-Gr. 46.02)	46.857321	15.60		
zu Optiflex-Dosen					
	WK-Stablehre (Rabatt-Gr. 46.03)	3m	46.859621	62.50 *	
	Optiflex-Rohrbride (Rabatt-Gr. 46.02)	50 Stück	16	46.877221	20.00
		50 Stück	20	46.877222	27.50
	Optiflex-Markier- und Abdecktülle (Rabatt-Gr. 46.02)	16 - R	46.877621	1.25	
		16 - G	46.877622	1.25	
		20 - R	46.877623	1.90	
		20 - G	46.877624	1.90	

* Netto Preise !

	Einlege & Befestigungsmaterial	Dim.	Artikel-Nr.	Fr. / Stk.
--	--------------------------------	------	-------------	------------

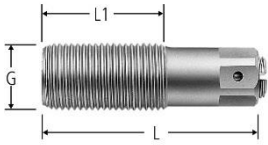

WK-Abpresszapfen

(Rabatt-Gr. 46.03)

1/2"

46.859804

9.70 *

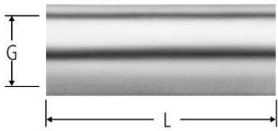

WK-Schutz- und Befestigungshülse

(Rabatt-Gr. 46.03)

1/2"

46.859904

5.70 *

Bau- und Abpresszapfen

(Rabatt-Gr. 45.09)



mit Messing-Gewinde
und Dichtung

Blau

1/2"

45.916804

2.00 *



Rot

1/2"

45.916805

2.00 *

* Netto Preise !



IRG Sanipex



IRG Sanipex Rohr

(Rabatt-Gr. 57.01)

PE-Xc, blau, in Schutzrohr,
in Ringen a 50m

16

57.716016

4.80

20

57.716020

6.60

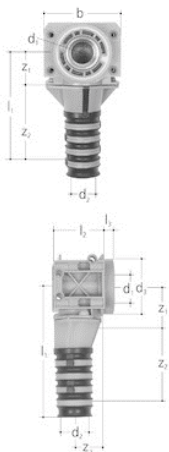

IRG Sanipex Dose 90°

(Rabatt-Gr. 57.01)

Bestehend aus Dosenkörper,
Dosenfuss und Bördelverschraubung

16 x 1/2"

57.400100

26.00

20 x 1/2"

57.400200

39.30

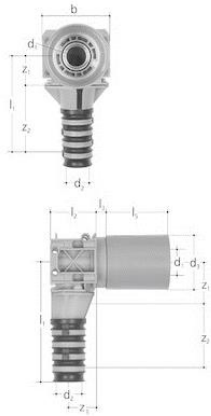
IRG Sanipex
Artikel-Nr.
Fr. / Stk.

**IRG Sanipex Dose 90°
mit Verlängerung**

(Rabatt-Gr. 57.01)

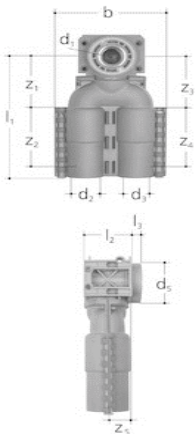
 Bestehend aus Dosenkörper,
Dosenfuss, Befestigungsclip,
Verschraubungen & Verlängerung

16 x 1/2"
57.400160
28.50
20 x 1/2"
57.400260
42.10

IRG Sanipex Dose 2-fach

(Rabatt-Gr. 57.01)

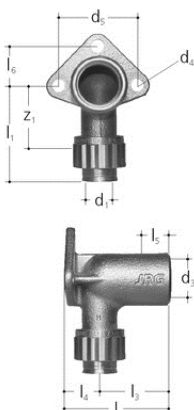
 Bestehend aus Dosenkörper,
Dosenfuss und Bördelverschraubung

16 x 16 x 1/2"
57.404100
45.90
20 x 16 x 1/2"
57.404200
52.00
20 x 20 x 1/2"
57.404300
63.00

**IRG Sanipex
Armaturenanschluss, einfach**

(Rabatt-Gr. 57.01)

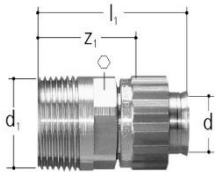
16 x 1/2"
57.415050
20.90
20 x 1/2"
57.415058
23.40

IRG Sanipex
Artikel-Nr.
Fr. / Stk.

**IRG Sanipex
Übergang mit Aussengewinde**

(Rabatt-Gr. 57.01)

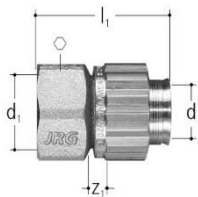
16 x 1/2"	57.480908	11.70
16 x 3/4"	57.480918	15.20
20 x 1/2"	57.480921	15.80
20 x 3/4"	57.480922	22.10

**IRG Sanipex
Übergang mit Innengewinde**

(Rabatt-Gr. 57.01)

16 x 1/2"	57.484908	12.00
16 x 3/4"	57.484918	15.20
20 x 1/2"	57.484921	15.80
20 x 3/4"	57.484922	22.10

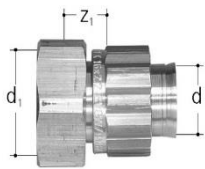
**IRG Sanipex
Übergang mit Konus**

(Rabatt-Gr. 57.01)

Für Fremdfabrikat-Verteiler

16 x 3/4"	57.494016	14.90
-----------	-----------	-------

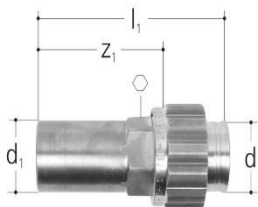
**IRG Sanipex
Übergang mit Press- & Lötende**



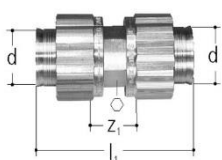

(Rabatt-Gr. 57.01)

15 x 16	57.502700	14.30
22 x 20	57.502715	39.10

**IRG Sanipex
Kupplung**

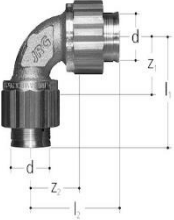
(Rabatt-Gr. 57.01)

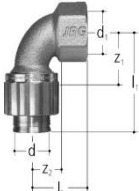
16	57.510016	14.70
20	57.510020	25.80

IRG Sanipex		Artikel-Nr.	Fr. / Stk.
	IRG Sanipex Bogen 90° (Rabatt-Gr. 57.01)	16	57.520016 15.80
		20	57.520020 25.00
	IRG Sanipex Bogen 90° mit Aussengewinde (Rabatt-Gr. 57.01)	16 x 1/2"	57.524908 17.60
		20 x 1/2"	57.524921 20.90
	IRG Sanipex Bogen 90° mit Innengewinde (Rabatt-Gr. 57.01)	16 x 1/2"	57.521908 17.60
		20 x 1/2"	57.521921 21.20
	IRG Sanipex T-Stück mit Aussengewinde (Rabatt-Gr. 57.01)	1/2" x 16 x 16	57.465970 21.20
	IRG Sanipex T-Stück (Rabatt-Gr. 57.01)	16 x 16 x 16	57.470016 20.90
		20 x 20 x 20	57.470020 34.00
		20 x 16 x 16	57.470880 33.40
		20 x 16 x 20	57.470881 33.40
		20 x 20 x 16	57.470882 34.00
		16 x 20 x 16	57.470883 34.00

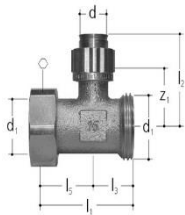
IRG Sanipex
Artikel-Nr.
Fr. / Stk.

**IRG Sanipex
Verteiler 1-fach**

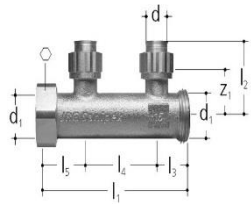
(Rabatt-Gr. 57.01)

16 x 1"
57.420016
24.80
20 x 1"
57.420020
32.30

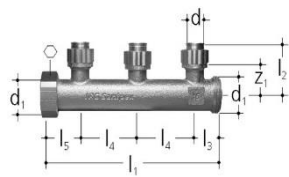
**IRG Sanipex
Verteiler 2-fach**

(Rabatt-Gr. 57.01)

16 x 1"
57.421016
32.30
20 x 1"
57.421020
52.00

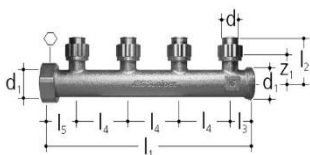
**IRG Sanipex
Verteiler 3-fach**

(Rabatt-Gr. 57.01)

16 x 1"
57.422016
46.80
20 x 1"
57.422020
74.00

**IRG Sanipex
Verteiler 4-fach**

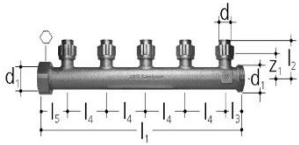
(Rabatt-Gr. 57.01)

16 x 1"
57.423016
60.00

IRG Sanipex
Artikel-Nr.
Fr. / Stk.

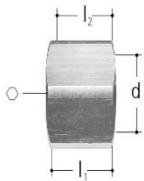
**IRG Sanipex
Verteiler 5-fach**

(Rabatt-Gr. 57.01)

16 x 1"
57.424016
74.00

**IRG Sanipex
Kappe für Verteiler**

(Rabatt-Gr. 57.01)

Rotguss

3/4"
57.427090
5.30

Messing

1"
57.430000
5.80
IRG Sanipex Rohr - Zugkupplung & Montagekoffer

siehe Werkzeug Kapitel 7

Zulassungen:

 Schweizerischer Verein des
Gas- und Wasserfaches

Verbundrohr PERT-AL-PE JANSEN prima

(Rabatt-Gr. 51.07)

	Rollenlänge	Dim.		pro Meter
Betriebsdruck max. 10 bar	100 m	16x2	51.000953	3.00
Betriebstemp. max. 95°	100 m	20x2	51.000954	4.20
	50 m	26x3	51.000955	6.80
	50 m	32x3	51.000957	11.95

Verbundrohr PERT-AL-PE JANSEN prima

(Rabatt-Gr. 51.16)



in Stangen à 5 Meter	Dim.		
	16x2	51.000940	3.60
	20x2	51.000941	4.70
	26x3	51.000942	7.60
	32x3	51.000943	12.60
	40x3.5	51.000944	18.90
	50x4	51.000945	23.90
	63x6	51.000946	37.60

**Verbundrohr PERT-AL-PE
mit 6 mm Isolation**

(Rabatt-Gr. 51.07)

Rot	50 m	20x2	51.000920	5.95
Rot	25 m	26x3	51.000921	8.90

PB-Rohr im Schutzrohr

(Rabatt-Gr. 51.07)

Blau	50 m	16 x 2	51.000930	3.00
Blau	50 m	20 x 2	51.000931	4.50

**Pressübergang mit
Aussengewinde**

3/8" x 16	51.404514	3.40
1/2" x 16	51.404516	2.50
3/4" x 16	51.404517	4.00
1/2" x 20	51.404520	3.15
3/4" x 20	51.404521	4.40
3/4" x 26	51.404525	6.25
1" x 26	51.404526	8.00
1" x 32	51.404532	8.90
1.1/4" x 32	51.404533	12.25

Pressfittings Verbundrohr (TH) (Rabatt-Gr. 51.07) Artikel-Nr. Fr. / Stk.



Pressübergang mit Innengewinde

1/2" x 16	51.404716	3.15
3/4" x 16	51.404717	5.75
1/2" x 20	51.404720	3.90
3/4" x 20	51.404721	5.15
3/4" x 26	51.404725	6.90
1" x 26	51.404726	8.75
1" x 32	51.404732	9.80
1.1/4" x 32	51.404733	19.85



Presskupplung

16	51.404016	3.85
20	51.404020	4.85
26	51.404025	7.20
32	51.404032	11.00



Presskupplung reduziert

20 x 16	51.404022	5.05
26 x 16	51.404023	6.75
26 x 20	51.404027	6.90
32 x 16	51.404028	9.95
32 x 20	51.404029	10.10
32 x 26	51.404033	10.10



Presswinkel 90°

16	51.401016	4.75
20	51.401020	5.65
26	51.401025	8.60
32	51.401032	11.65

Pressfittings Verbundrohr (TH) (Rabatt-Gr. 51.07) Artikel-Nr. Fr. / Stk.



Presswinkel 45°

26	51.401033	13.90
32	51.401034	15.90



Presswinkel mit Aussengewinde

1/2" x 16	51.401516	5.00
1/2" x 20	51.401520	5.65
3/4" x 20	51.401521	5.90
3/4" x 26	51.401525	7.90
1" x 32	51.404526	10.35



Presswinkel mit Innengewinde

1/2" x 16	51.401816	4.00
1/2" x 20	51.401820	5.40
3/4" x 20	51.401821	7.25
3/4" x 26	51.401822	8.35
1" x 32	51.401823	10.60



Press - T - Stück

16	51.303016	6.25
20	51.303020	7.95
26	51.303025	12.30
32	51.303032	18.55

Press - T - Stück reduziert



20 x 16 x 20	51.303021	8.25
20 x 16 x 16	51.303022	8.15
20 x 20 x 16	51.303023	8.75
26 x 16 x 26	51.303027	12.85
26 x 20 x 26	51.303026	12.85
26 x 16 x 20	51.303035	12.25
26 x 20 x 16	51.303036	12.85
26 x 20 x 20	51.303037	12.85
26 x 26 x 16	51.303038	12.85
26 x 26 x 20	51.303039	12.85
32 x 26 x 26	51.303041	18.15
32 x 26 x 32	51.303030	18.15
32 x 32 x 20	51.303042	18.15
32 x 32 x 26	51.303043	18.15



Press - T - Stück mit Innengewinde

16 x 1/2" x 16	51.403516	7.70
20 x 1/2" x 20	51.403520	8.20
26 x 1/2" x 26	51.403525	11.10
32 x 1/2" x 32	51.403532	17.20



Press - Flanschwinkel

1/2" x 16	51.400916	5.65
1/2" x 20	51.400917	6.75



Press - Doppel - Flanschwinkel

16x1/2"x16	51.400920	11.00
------------	-----------	-------

Übergangs-Press-Verschraubung



16x2 x 1/2"	51.422006	4.95
16x2 x 3/4"	51.422007	5.60
20x2 x 1/2"	51.422008	6.15
20x2 x 3/4"	51.422009	6.05
26x3 x 1"	51.422010	9.25
26x3 x 1.1/4"	51.422011	13.90
32x3 x 1"	51.422012	15.10
32x3 x 1.1/4"	51.422013	15.80
40x3.5 x 1.1/4"	51.422016	18.10
40x3.5 x 1.1/2"	51.422017	19.30



Für Sanitärrohre

16x2,2 und 20x2,8



Sanitär Rohr im Rohr

(Rabatt-Gr. 46.09)

PEX

16 x 2,2	46.874041	3.20
20 x 2,8	46.874042	4.90



**Übergangverschraubung
mit Aussengewinde**

(Rabatt-Gr. 46.09)

auf Basis Eurokonus
aussen vernickelt

1/2" x 16	46.871021	9.90
1/2" x 20	46.871022	10.70
3/4" x 16	46.871023	11.50
3/4" x 20	46.871024	12.30

**Übergangverschraubung
mit Innengewinde**

(Rabatt-Gr. 46.09)

auf Basis Eurokonus	1/2" x 16	46.871121	9.90
aussen vernickelt	1/2" x 20	46.871122	10.70
	3/4" x 16	46.871123	12.00
	3/4" x 20	46.871124	12.80

Doppelkupplung

(Rabatt-Gr. 46.09)

auf Basis Eurokonus	16 x 16	46.871821	14.20
aussen vernickelt	20 x 20	46.871822	15.80

**Übergangswinkelverschraubung
mit Aussengewinde**

(Rabatt-Gr. 46.09)

auf Basis Eurokonus	1/2" x 16	46.872021	11.70
aussen vernickelt	1/2" x 20	46.872022	12.50

**Übergangswinkelverschraubung
mit Innengewinde**

(Rabatt-Gr. 46.09)

auf Basis Eurokonus	1/2" x 16	46.872121	11.70
aussen vernickelt	1/2" x 20	46.872122	12.50

PEX - Verschraubungsprogramm
Artikel-Nr. Fr. / Stk.

Winkelverschraubung

(Rabatt-Gr. 46.09)

auf Basis Eurokonus	16 x 16	46.872821	16.30
aussen vernickelt	20 x 20	46.872822	17.90

T-Verschraubungen

(Rabatt-Gr. 46.09)

auf Basis Eurokonus	16 x 16 x 16	46.873821	18.00
aussen vernickelt	20 x 16 x 16	46.873822	23.50
	20 x 16 x 20	46.873823	23.50
	20 x 20 x 16	46.873824	23.50
	20 x 20 x 20	46.873825	23.50

T-Verschraubungen mit IG

(Rabatt-Gr. 46.09)

auf Basis Eurokonus	16 x 1/2" x 16	46.870221	14.00
aussen vernickelt	20 x 1/2" x 20	46.870222	15.20

Flanschwinkel

(Rabatt-Gr. 46.09)

auf Basis Eurokonus	1/2" x 16	46.870021	13.00
aussen vernickelt	1/2" x 20	46.870022	13.70

Verteiler

(Rabatt-Gr. 46.09)

 auf Basis Eurokonus
 aussen vernickelt

3/4" x 2	46.870622	19.20
3/4" x 3	46.870623	24.20
3/4" x 4	46.870624	31.00

Anschlussverschraubung

(Rabatt-Gr. 46.09)

 auf Basis Eurokonus
 aussen vernickelt

3/4" x 16	46.870521	4.50
3/4" x 20	46.870522	5.20



Inox Pressfittings

Rohre

Fittinge



V4A Edelstahlrohr

1.4404

15	64.239915	7.15
18	64.239918	10.30
22	64.239922	14.40
28	64.239928	17.90
35	64.239935	26.10



Bogen 90°

mit beidseitiger Pressmuffe

15	64.232015	7.75
18	64.232018	9.20
22	64.232022	10.60
28	64.232028	13.35
35	64.232035	21.00



Bogen 90°

mit Einsteckende

15	64.232415	7.90
18	64.232418	9.00
22	64.232422	10.60
28	64.232428	13.20
35	64.232435	21.00

INOX-P Pressfittings M-Kontur (Rabatt-Gr. 64.01)
Artikel-Nr.
Fr. / Stk.

Bogen 45°

mit beidseitiger Pressmuffe

15	64.232715	10.60
18	64.232718	11.30
22	64.232722	13.10
28	64.232728	15.30
35	64.232735	19.60

Bogen 45°

mit Einsteckende

15	64.232815	10.60
18	64.232818	11.30
22	64.232822	13.00
28	64.232828	15.20
35	64.232835	18.50

Muffe

15	64.230015	5.50
18	64.230018	5.90
22	64.230022	7.05
28	64.230028	8.50
35	64.230035	9.80

Schiebemuffe

15	64.230415	9.00
18	64.230418	9.30
22	64.230422	10.60
28	64.230428	12.40
35	64.230435	13.90

Reduktion

18 x 15	64.234318	6.40
22 x 15	64.234322	6.95
22 x 18	64.234323	7.40
28 x 15	64.234328	8.95
28 x 18	64.234329	8.75
28 x 22	64.234330	9.10
35 x 15	64.234335	16.95
35 x 18	64.234336	17.50
35 x 22	64.234337	11.40
35 x 28	64.234338	12.55

Übergang mit Innengewinde

1/2" x 15	64.230215	11.50
1/2" x 18	64.230218	12.20
1/2" x 22	64.230221	12.95
3/4" x 22	64.230222	15.25
1" x 22	64.230223	17.40
3/4" x 28	64.230227	16.60
1" x 28	64.230228	23.70
1.1/4" x 35	64.230235	26.00

Übergang mit Aussengewinde

1/2" x 15	64.230115	11.80
1/2" x 18	64.230118	11.80
1/2" x 22	64.230121	12.70
3/4" x 22	64.230122	13.30
1" x 22	64.230123	16.70
3/4" x 28	64.230127	16.30
1" x 28	64.230128	16.90
1.1/4" x 28	64.230129	20.60
1.1/4" x 35	64.230135	24.70

Winkel mit Aussengewinde

1/2" x 15	64.233115	14.30
1/2" x 18	64.233118	15.00
3/4" x 22	64.233122	19.20
1" x 28	64.233128	25.30
1.1/4" x 35	64.233135	38.00

Winkel mit Innengewinde

1/2" x 15	64.233215	16.40
1/2" x 18	64.233218	17.50
3/4" x 22	64.233222	21.30
1" x 28	64.233228	30.70
1.1/4" x 35	64.233235	43.40

INOX-P Pressfittings M-Kontur (Rabatt-Gr. 64.01)
Artikel-Nr.
Fr. / Stk.

Deckenwinkel 90°

1/2" x 15	64.235015	18.60
1/2" x 18	64.235018	18.90
3/4" x 22	64.235022	27.10

Deckenwinkel lang 90°

1/2" x 15	64.235415	23.60
1/2" x 18	64.235418	24.10

T-Stück egal

15	64.231015	13.70
18	64.231018	14.10
22	64.231022	16.20
28	64.231028	18.95
35	64.231035	25.80
42	64.231042	35.80
54	64.231054	42.10

T-Stück reduziert

18 x 15 x 18	64.231118	16.10
22 x 15 x 22	64.231122	15.55
22 x 18 x 22	64.231123	16.10
28 x 15 x 28	64.231128	16.00
28 x 18 x 28	64.231129	17.00
28 x 22 x 28	64.231130	17.90
35 x 15 x 35	64.231135	20.30
35 x 18 x 35	64.231136	20.50
35 x 22 x 35	64.231137	21.50
35 x 28 x 35	64.231138	22.50

T-Stück mit Innengewinde

15 x 1/2" x 15	64.231215	16.70
18 x 1/2" x 18	64.231218	17.40
22 x 1/2" x 22	64.231222	18.00
28 x 1/2" x 28	64.231228	20.70
35 x 1/2" x 35	64.231235	23.80

Verlängerungen
Artikel-Nr.
Fr. / Stk.
Hahnenverlängerung

(Rabatt-Gr. 25.01)

RG bzw. Messing blank



3/8" x 10	25.710000	3.30
3/8" x 15	25.710001	3.70
3/8" x 20	25.710002	4.60
3/8" x 25	25.710003	5.30
3/8" x 30	25.710004	5.70
3/8" x 40	25.710005	7.25
3/8" x 50	25.710006	8.80
3/8" x 65	25.710007	8.00
1/2" x 10	25.710020	3.60
1/2" x 15	25.710021	3.90
1/2" x 17.5	25.710030	4.10
1/2" x 20	25.710022	4.25
1/2" x 25	25.710023	4.50
1/2" x 30	25.710024	4.70
1/2" x 40	25.710025	6.10
1/2" x 50	25.710026	8.10
1/2" x 65	25.710027	9.80
1/2" x 80	25.710028	12.80
1/2" x 100	25.710029	15.50
3/4" x 15	25.710040	5.00
3/4" x 20	25.710041	5.80
3/4" x 25	25.710042	6.90
3/4" x 30	25.710043	7.70
3/4" x 40	25.710044	10.50
3/4" x 50	25.710045	12.30
3/4" x 65	25.710046	16.30
3/4" x 80	25.710047	24.10
3/4" x 100	25.710048	27.60

Verlängerungen

Artikel-Nr.

Fr. / Stk.

Hahnenverlängerung

(Rabatt-Gr. 25.01)



RG bzw. Messing blank

1" x 15	25.710060	10.30
1" x 20	25.710061	12.10
1" x 25	25.710062	14.10
1" x 30	25.710063	15.80
1" x 40	25.710064	19.10
1" x 50	25.710065	22.60
1" x 65	25.710066	23.10

Hahnenverlängerung reduziert

(Rabatt-Gr. 45.01)



RG bzw. Messing blank

1/2" x 3/8"	45.902323	7.30
3/4" x 1/2"	45.902326	10.20
1" x 3/4"	45.902329	23.70
1.1/4" x 1"	45.902332	25.80

Winkel 90° Nr. 3090

(Rabatt-Gr. 19.01)



aus Rotguss

3/8"	19.309002	9.70
1/2"	19.309003	9.15
3/4"	19.309004	12.40
1"	19.309005	22.90
1.1/4"	19.309006	42.70
1.1/2"	19.309007	62.10
2"	19.309008	110.15

Rotguss-Schraubfittings		Artikel-Nr.	Fr. / Stk.
	Winkel 90° Nr. 3090 reduziert (Rabatt-Gr. 19.01)		
	aus Rotguss	1/2" x 3/8" 19.309012	24.60
		3/4" x 1/2" 19.309013	25.80
		1" x 3/4" 19.309014	45.55
	Winkel 90° Nr. 3092 (Rabatt-Gr. 19.01)		
	aus Rotguss	3/8" 19.309202	11.20
		1/2" 19.309203	10.75
		3/4" 19.309204	13.85
		1" 19.309205	23.75
		1.1/4" 19.309206	40.05
		1.1/2" 19.309207	64.15
	2" 19.309208	116.50	
	Winkel 45° Nr. 3121 (Rabatt-Gr. 19.01)		
	aus Rotguss	1/2" 19.312102	19.40
		3/4" 19.312103	20.45
		1" 19.312104	26.45
		1.1/4" 19.312105	79.20
		1.1/2" 19.312106	122.30
	T-Stück Nr. 3130 (Rabatt-Gr. 19.01)		
	aus Rotguss	3/8" 19.313002	12.40
		1/2" 19.313003	10.95
		3/4" 19.313004	18.15
		1" 19.313005	27.25
		1.1/4" 19.313006	56.10
		1.1/2" 19.313007	76.10
	2" 19.313008	113.65	

Rotguss-Schraubfittings (Rabatt-Gr. 19.01)
Artikel-Nr.
Fr. / Stk.

**T-Stück Nr. 3130
reduziert**

(Rabatt-Gr. 19.01)

aus Rotguss

1/2" x 3/8" x 1/2"	19.313010	25.60
1/2" x 3/4" x 1/2"	19.313012	36.30
3/4" x 1/2" x 1/2"	19.313013	45.00
3/4" x 1/2" x 3/4"	19.313014	18.55
3/4" x 3/4" x 1/2"	19.313015	38.80
1" x 1/2" x 1"	19.313016	55.10
1" x 3/4" x 1"	19.313017	44.80
1" x 1" x 1/2"	19.313018	60.85
1.1/4" x 1" x 1.1/4"	19.313019	96.75

**Muffe Nr. 3240
reduziert**

(Rabatt-Gr. 19.01)

aus Rotguss

1/2" x 3/8"	19.324002	6.45
3/4" x 3/8"	19.324003	17.95
3/4" x 1/2"	19.324004	7.45
1" x 1/2"	19.324005	20.00
1" x 3/4"	19.324006	11.35
1.1/4" x 3/4"	19.324007	35.05
1.1/4" x 1"	19.324008	22.30
1.1/2" x 1"	19.324009	47.65
1.1/2" x 1.1/4"	19.324011	35.05
2" x 1.1/2"	19.324012	48.90

**Doppelnippel Nr. 3245
reduziert**

(Rabatt-Gr. 19.01)

aus Rotguss

1/2" x 3/8"	19.324501	4.00
3/4" x 1/2"	19.324502	5.00
1" x 3/4"	19.324503	9.30
1.1/4" x 1"	19.324504	21.70

Reduziernippel Nr. 3241

(Rabatt-Gr. 19.01)

aus Rotguss

3/8" x 1/4"	19.324101	2.90
1/2" x 3/8"	19.324102	2.90
3/4" x 3/8"	19.324104	6.45
3/4" x 1/2"	19.324105	4.55
1" x 1/2"	19.324106	7.80
1" x 3/4"	19.324107	7.25
1.1/4" x 1/2"	19.324108	22.30
1.1/4" x 3/4"	19.324109	18.80
1.1/4" x 1"	19.324110	10.40
1.1/2" x 1/2"	19.324114	51.80
1.1/2" x 3/4"	19.324115	38.00
1.1/2" x 1"	19.324116	21.70
1.1/2" x 1.1/4"	19.324113	19.60
2" x 1/2"	19.324122	64.80
2" x 3/4"	19.324121	58.60
2" x 1"	19.324119	42.70
2" x 1.1/4"	19.324118	32.50
2" x 1.1/2"	19.324117	28.90

Muffe Nr. 3270

(Rabatt-Gr. 19.01)

aus Rotguss

3/8"	19.327002	3.95
1/2"	19.327003	4.60
3/4"	19.327004	6.50
1"	19.327005	10.15
1.1/4"	19.327006	19.80
1.1/2"	19.327007	24.80
2"	19.327008	42.50

Rotguss-Schraubfittings Serie 3000
Artikel-Nr.
Fr. / Stk.

Doppelnippel Nr. 3280

(Rabatt-Gr. 19.01)

aus Rotguss

3/8"	19.328002	2.90
1/2"	19.328003	3.40
3/4"	19.328004	5.15
1"	19.328005	8.60
1.1/4"	19.328006	19.40
1.1/2"	19.328007	20.65
2"	19.328008	39.65

Stopfen Nr. 3290

(Rabatt-Gr. 19.01)

aus Rotguss

3/8"	19.329002	6.05
1/2"	19.329003	4.15
3/4"	19.329004	6.80
1"	19.329005	10.15
1.1/4"	19.329006	15.50
1.1/2"	19.329007	25.80
2"	19.329008	42.50

Kappe Nr. 3301

(Rabatt-Gr. 19.01)

aus Rotguss

3/8"	19.330101	5.00
1/2"	19.330102	3.55
3/4"	19.330103	7.05
1"	19.330104	17.35
1.1/4"	19.330105	20.00
1.1/2"	19.330106	27.65
2"	19.330107	62.10

Rotguss-Schraubfittings Serie 3000
Artikel-Nr.
Fr. / Stk.

Rohrverschraubung Nr. 3330

(Rabatt-Gr. 19.01)

 aus Rotguss
 flachdichtend

1/2"	19.333002	43.75
3/4"	19.333003	54.70
1"	19.333004	88.50
1.1/4"	19.333005	169.10
1.1/2"	19.333006	195.55
2"	19.333007	321.75

Rohrverschraubung Nr. 3331

(Rabatt-Gr. 19.01)

aus Rotguss

1/2"	19.333103	35.95
3/4"	19.333104	38.15
1"	19.333105	78.20
1.1/4"	19.333106	137.55
1.1/2"	19.333107	161.50
2"	19.333108	291.60

Rohrdoppelnippel Nr. 3530

(Rabatt-Gr. 19.02)

aus Messing

3/8" x 40	19.530101	6.30
3/8" x 60	19.530103	6.90
3/8" x 80	19.530105	7.80
3/8" x 100	19.530107	9.30
3/8" x 120	19.530109	16.20
1/2" x 30	19.530200	5.80
1/2" x 40	19.530201	5.80
1/2" x 50	19.530202	6.30
1/2" x 60	19.530203	6.80
1/2" x 70	19.530204	7.20
1/2" x 80	19.530205	9.00
1/2" x 90	19.530206	9.30
1/2" x 100	19.530207	9.50
1/2" x 120	19.530209	14.80

Rohrdoppelnippel Nr. 3530

(Rabatt-Gr. 19.02)



aus Messing

3/4" x 30	19.530300	6.00
3/4" x 40	19.530301	6.90
3/4" x 50	19.530302	7.50
3/4" x 60	19.530303	7.60
3/4" x 70	19.530304	10.60
3/4" x 80	19.530305	12.60
3/4" x 90	19.530306	13.90
3/4" x 100	19.530307	15.00
3/4" x 120	19.530309	19.80
3/4" x 150	19.530312	31.10
1" x 30	19.530400	8.80
1" x 40	19.530401	8.20
1" x 50	19.530402	10.50
1" x 60	19.530403	11.10
1" x 70	19.530404	13.30
1" x 80	19.530405	18.30
1" x 90	19.530406	18.90
1" x 100	19.530407	20.10
1" x 120	19.530409	27.00
1" x 150	19.530412	34.20
1.1/4" x 40	19.530501	25.10
1.1/4" x 50	19.530502	25.50
1.1/4" x 60	19.530503	25.90
1.1/4" x 70	19.530504	27.10
1.1/4" x 80	19.530505	28.80
1.1/4" x 90	19.530506	25.20
1.1/4" x 100	19.530507	25.40
1.1/2" x 40	19.530601	28.20
1.1/2" x 60	19.530603	29.10
1.1/2" x 80	19.530605	31.50
1.1/2" x 100	19.530607	29.50
2" x 100	19.530708	40.80

Chrome - Fittings		Artikel-Nr.	Fr. / Stk.
Hahnenverlängerung			
(Rabatt-Gr. 25.01)		3/8" x 10	25.916051 3.50
		3/8" x 15	25.916052 3.75
Messing verchromt		3/8" x 20	25.916053 5.40
		3/8" x 25	25.916054 5.80
		3/8" x 30	25.916055 6.30
		3/8" x 40	25.916056 5.70
		1/2" x 15	25.916062 4.65
		1/2" x 20	25.916063 5.40
		1/2" x 25	25.916064 5.90
		1/2" x 30	25.916065 7.00
		1/2" x 40	25.916066 8.00
		1/2" x 50	25.916067 10.00
			
Winkel 90°, mit Aussengewinde			
(Rabatt-Gr. 45.01)		1/2"	45.910054 19.60
Messing verchromt		3/4"	45.910055 28.90
			
Winkel 90°, mit Aussengewinde			
(Rabatt-Gr. 45.01)		1/2"	45.910154 19.60
Messing verchromt		3/4"	45.910155 28.90
			
T-Stück			
(Rabatt-Gr. 45.01)		1/2"	45.910254 25.50
Messing verchromt		3/4"	45.910255 34.00
			
Muffe			
(Rabatt-Gr. 45.01)		1/2"	45.911054 10.50
Rotguss verchromt		3/4"	45.911055 12.00
			

Chrome - Fittings		Artikel-Nr.	Fr. / Stk.
	Doppelnippel		
	(Rabatt-Gr. 45.01)	3/8"	45.912053 6.10
		1/2"	45.912054 8.10
	Rotguss verchromt	3/4"	45.912055 10.50
		1"	45.912056 18.20
	Doppelnippel, reduziert		
	(Rabatt-Gr. 45.01)	3/8" x 1/2"	45.912172 10.00
		1/2" x 3/4"	45.912173 10.50
	Rotguss verchromt	1/2" x 1"	45.912174 21.40
		3/4" x 1"	45.912175 24.80
	Reduktion		
	(Rabatt-Gr. 45.01)	3/8" x 1/4"	45.912671 5.70
		1/2" x 3/8"	45.912672 5.70
	Rotguss verchromt	3/4" x 1/2"	45.912674 7.40
		1" x 1/2"	45.912675 18.20
		1" x 3/4"	45.912676 12.30
	Stopfen		
	(Rabatt-Gr. 45.01)	1/2"	45.913054 9.40
	Messing verchromt	3/4"	45.913055 12.50
	Verschlusskappe		
	(Rabatt-Gr. 45.01)	3/8"	45.914053 6.60
		1/2"	45.914054 7.40
	Messing verchromt	3/4"	45.914055 9.80
		1"	45.914056 11.10
		1 1/4"	45.914057 29.60
	1 1/2"	45.914058 43.40	

Klemmring-Verschraubungen	Dim.	Artikel-Nr.	Fr. / Stk.
---------------------------	------	-------------	------------

Klemmring-Verschraubung

(Rabatt-Gr. 49.04)
mit Aussengewinde



3/8"	49.330049	27.35
1/2"	49.330050	25.80
3/4"	49.330051	30.30
1"	49.330052	31.80
1.1/4"	49.330053	42.90
1.1/2"	49.330054	48.10
2"	49.330055	73.70

Klemmring-Verschraubung

(Rabatt-Gr. 49.04)
mit Innengewinde



3/8"	49.330059	25.40
1/2"	49.330060	25.80
3/4"	49.330061	29.90
1"	49.330062	33.70
1.1/4"	49.330063	43.50
1.1/2"	49.330064	51.00
2"	49.330065	73.20

Klemmring-Kupplung

(Rabatt-Gr. 49.04)



3/8"	49.330069	35.60
1/2"	49.330070	34.90
3/4"	49.330071	37.10
1"	49.330072	44.25
1.1/4"	49.330073	61.50
1.1/2"	49.330074	63.85
2"	49.330075	106.70

Klemmring-T-Stück

(Rabatt-Gr. 49.04)
mit Abgang Innengewinde



1/2"	49.330130	38.20
3/4"	49.330131	44.20
1"	49.330132	54.40
1.1/4"	49.330133	72.40

UNI-Grip & UNI-Rep
Artikel-Nr.
Fr. / Stk.
UNI-Grip L PN16 EPDM

(Rabatt-Gr. 17.04)

für Metall - Metall Verbindungen
 Einsatztemperatur -30°C bis +125°C
 Geeignet für Trink- & Abwasser,
 Druckluft, Fest- & Chemische Stoffe

in mm

26.9 - 28.0	17.000026	60.00
33.7 - 35.0	17.000033	64.00
38.0	17.000038	74.00
42.4	17.000042	75.00
48.3	17.000048	79.00
54.0 - 57.0	17.000057	90.00
60.3 - 63.0	17.000060	93.00
66.6 - 70.0	17.000070	107.00
73.0 - 79.5	17.000076	127.00
88.9	17.000088	137.00
104.8 - 110.0	17.000108	147.00
114.3 - 118.0	17.000114	151.00
130.2 - 133.0	17.000133	208.00
139.7 - 141.6	17.000139	212.00
159.0	17.000159	224.00
165.0 - 168.3	17.000168	231.00

UNI-Rep L PN16 EPDM

(Rabatt-Gr. 17.04)

für Metall - Metall Verbindungen
 für Kunststoff - Kunststoff Verbindungen
 für Metall - Kunststoff Verbindungen
 Einsatztemperatur -30°C bis +125°C
 Geeignet für Trink- & Abwasser,
 Druckluft, Fest- & Chemische Stoffe

in mm

42.4	17.001424	140.00
48.3	17.001483	140.00
60.3 - 63.0	17.001603	145.00
73.0 - 79.5	17.001761	175.00
88.9	17.001889	180.00
104.8 - 110.0	17.001108	191.00
130.2 - 133.0	17.001133	241.00
159.0	17.001159	255.00

